



■ Some of the photos may include optional equipment.

HYUNDAI MATERIAL HANDLING Applied Tier 4 Engine

# 70L-7A



Head Office (Sales office)

First tower, 55, Bundang-ro, Bundang-gu, Seongnam-si, Gyeonggi-do, Korea

PLEASE CONTACT

[www.hyundai-ce.com](http://www.hyundai-ce.com)

2018. 07 Rev 5



# Beyond the Limits

Hyundai introduces a new line of 7A series LPG forklift trucks. Excellent power and performance make your business more profitable.



■ Some of the photos may include optional equipment.



# The new master on the job-site!

Smooth running, efficient and ergonomically designed, 70L-7A series are made to meet your needs.

**78kW/2,300rpm**



## Powerful Engine PSI 4.3L V6 Engine

Market approved quality of PSI 4.3L V6 engine ensures incomparable performance, durability and additional value to the machine. Powerful and efficient engine provides excellent fuel economy and excellent torque for improved operation.  
(EPA/CARB Tier-IV Certified)

## Fast and Stable Performance

Being able to quickly raise and lower the mast, as well as tilt it forward and backward, provides the best operational conditions during unloading.

When the truck is fully loaded, mast lowering speed is carefully controlled to ensure safety by the down control valve.

Mast(Lift and Tilt) Look System is standard.



Some of the photos may include optional equipment.

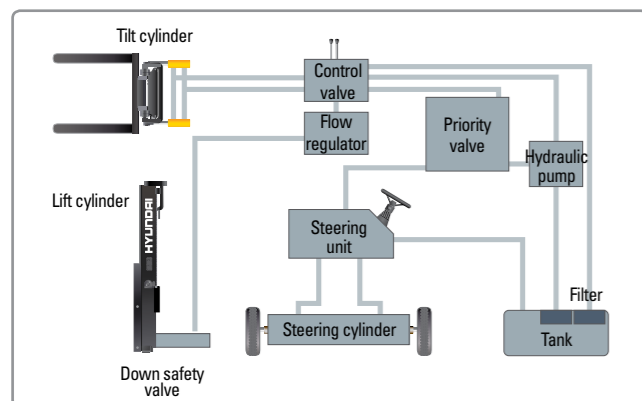

## State-of-the-art Hydraulic System

The latest large-capacity hydraulic system reacts quickly during operation, and a low-noise control valve increases both efficiency and durability.



## Fully Hydrostatic Power Steering

A hydraulic steering system always guarantees smooth and flexible steering, preventing overrun and kick-back.



## Increased Mast Tilting Angle

Utilizing the mast tilting angle of 15 degrees forward and 10 degrees backward, the operator can safely and rapidly perform loading and unloading jobs.

## Faster Travel Speed & Better Gradability

The powerful high-output engine provides greater acceleration, better gradability and faster travel speed on any tough terrains or slopes.



**Gradability(Loaded)**  
70L-7A : 40.6%

**Travel Speed(Unloaded)**  
70L-7A : 22.4 km/h



# Ergonomic operator friendly compartment design!

A design based on human engineering relieves fatigue and increases operator's efficiency.

## Operator Friendly Gauges and Water-resistant Monitor Panel



- 1 Parking brake lamp
- 2 Turn lamp
- 3 Engine oil warning lamp
- 4 Transmission oil temperature warning lamp
- 5 Battery charging warning lamp
- 6 Air cleaner filter warning light
- 7 Working light indicator
- 8 Seat belt warning
- 9 Water temperature gauge
- 10 OPS warning (option)
- 11 Hour meter
- 12 Engine check lamp
- 13 Brake oil warning lamp



**Full Suspension Seat**  
An attractive and adjustable seat, based on a human engineering design, provides great comfort, safety and durability.



**New High Visibility for Safe Operation**  
The operator is able to work with increased safety and accuracy due to a wider view mast.



Some of the photos may include optional equipment.



**Ergonomically Positioned Pedals**  
Based on human engineering, the accelerator, brake and inching pedals are optimally positioned for convenience while operating the equipment.



**Cup Holder & Console Box**  
Additional storage spaces are located inside the operating space for operator's convenience.



**Quick Response of Operating Control Levers**  
Only minimal operator's effort is required for precise, safe and productive control.



**Adjustable Steering Wheel**  
Steering wheel with horn button can be adjusted by a lever on the right-hand side for the most comfortable operator position.



**Easy and Safe Shift Lever**  
A single lever on the left side of the steering column gives the operator fast, easy control of direction. The lever must be in the neutral position before the engine can be started.



# Danger-free through high durability!

Safety and durability are priorities in design of the equipment.

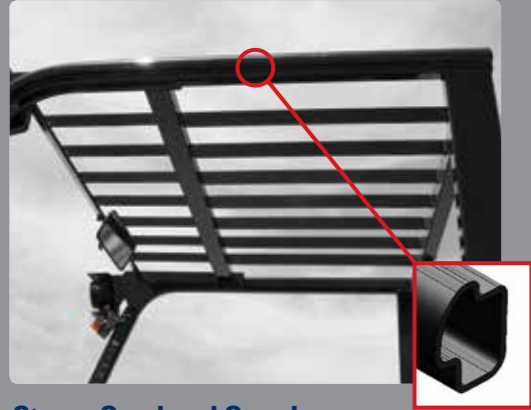

### Strong Overhead Guard

The safety overhead guard meets ISO 6055 regulation and protects the operator during hazardous jobs.



### Parking brake

Ratchet type parking brake requires less effort the operator to set.

### Highly Durable Split type Drive Axle

The planetary reduction drive axle smoothly delivers desired torque to the drive wheels.



Some of the photos may include optional equipment.

### OPSS (Operator Presence Sensing System)

Control of mast tilting, lifting and lowering is not possible through operation of the appropriate control when the operator is not in the seated position. (Option)



### Large Footboard & Hand Grip

Wide "open" step offers convenience and safety when entering and exiting truck.

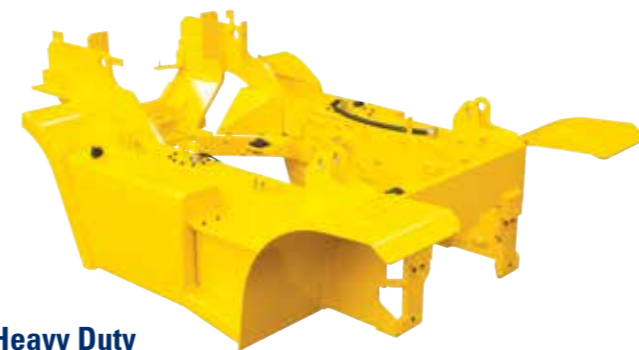

### Heavy Duty Single Unit Frame

Heavy duty single unit type frame, designed on the basis of accurate structural analysis, guarantees durability and safety.



### Bright, Protected Headlights

Bright, Protected head lights are positioned for exceptional visibility.

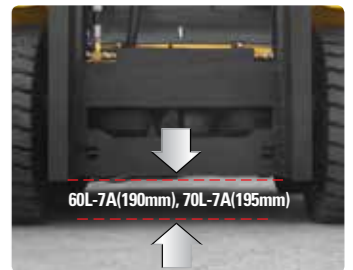

### Ground Clearance

The engine and transmission are assembled horizontally and positioned high in the frame to protect major components during operation on rugged surface.



## Designed for quick and easy service!

An ideal arrangement of component parts ensures easy access and convenience for maintenance.



**Large Engine Hood**  
Highly accessible engine compartment assures fast and efficient maintenance.



**Easy Change Air Cleaner**  
The air filter is readily accessible for cleaning or replacement.



**Up-to-date Cooling System**



■ Some of the photos may include optional equipment.



**Brake Fluid Reservoir with Level Switch**  
When brake oil level became lower than Min., the warning lamp on the cluster lights on.



**Easy Maintenance Oil Check**  
The T/M oil level can be checked easily without any disassembly.



**Expansion Bellows**  
The expansion bellows absorbs vibration and reduces noise generated from the exhaust system and also extends the life cycle of exhaust system.



**Grease Fittings**  
Grease fittings are installed for fast access to steering axle center pin when doing your service checks.



**Maintenance Free Battery**



**Large Tool Box**  
Additional tool box located in machine side for operator's convenience.



**Easy-to-access Reservoir Tank**



**Wing Cover Locking System**



### Mast Specification (70L-7A) STD : Hook Type Fork&carriage

Model	Mast Type	Maximum Fork height		Overall Height								Free Lift				Tilt Angle		Load capacity w/o side shift At 24 in (600mm)LC		Load capacity w/side shift At 24 in (600mm) LC		TRUCK WEIGHT UNLOADED	
				Lowered		Extended				Without Load Backrest		With Std Load Backrest											
				in	mm	in	mm	W/o Load Backrest		W/Std Load Backrest		in	mm	in	mm	Fwd	Bwd	lb	kg	lb	kg	lb	kg
						in	mm	in	mm	deg	deg												
70L-7A	2-STAGE LIMITED FREE LIFT	V270	107	2730	93	2365	154	3911	158.3	4020	5.5	140	5.5	140	15	10	15436	7000	15436	7000	20689	9382	
		V300	119	3030	99	2515	166	4211	170.1	4320	5.5	140	5.5	140	15	10	15436	7000	15436	7000	20794	9430	
		V330	131	3330	105	2665	178	4511	181.9	4620	5.5	140	5.5	140	15	10	15436	7000	15436	7000	20899	9478	
		V350	139	3530	109	2765	185	4711	189.8	4820	5.5	140	5.5	140	15	10	15436	7000	15436	7000	20969	9509	
		V370	147	3730	113	2865	193	4911	197.6	5020	5.5	140	5.5	140	15	10	15436	7000	15436	7000	21039	9541	
		V400	159	4030	119	3015	205	5211	209.4	5320	5.5	140	5.5	140	15	10	15436	7000	15436	7000	21163	9597	
		V450	178	4530	131	3315	225	5711	229.1	5820	5.5	140	5.5	140	15	10	15436	7000	15215	6900	21665	9825	
		V500	198	5030	140	3565	245	6211	248.8	6320	5.5	140	5.5	140	15	10	15436	7000	14774	6700	21841	9905	
	3-STAGE FULL FREE LIFT	V550	218	5530	150	3815	264	6711	268.5	6820	5.5	140	5.5	140	15	10	15215	6900	14333	6500	22016	9984	
		V600	237	6030	160	4065	284	7211	288.2	7320	5.5	140	5.5	140	15	10	14774	6700	14002	6350	22189	10063	
		V700	277	7030	180	4565	323	8211	327.6	8320	5.5	140	5.5	140	15	6	14553	6600	13451	6100	22534	10219	
		TF450	180	4560	101	2565	227	5765	228.5	5805	53.5	1360	50	1275	15	10	15436	7000	14553	6600	22124	10033	
		TF500	199	5060	109	2765	247	6265	248.2	6305	61.4	1560	58	1475	15	10	14994	6800	14112	6400	22327	10125	
		TF560	220	5600	117	2965	268	6805	269.5	6845	69.3	1760	66	1675	15	10	14553	6600	13671	6200	22572	10236	
		TF600	239	6060	125	3165	286	7265	287.6	7305	77.2	1960	74	1875	15	10	14112	6400	13341	6050	22765	10324	
		TS450	180	4560	101	2565	227	5765	228.5	5805	53.5	1360	50	1275	15	10	15436	7000	14553	6600	22124	10033	
TS500	199	5060	109	2765	247	6265	248.2	6305	61.4	1560	58	1475	15	10	14994	6800	14112	6400	22327	10125			
TS560	220	5600	117	2965	268	6805	269.5	6845	69.3	1760	66	1675	15	10	14553	6600	13671	6200	22572	10236			
TS600	239	6060	125	3165	286	7265	287.6	7305	77.2	1960	74	1875	15	10	14112	6400	13341	6050	22765	10324			

### Mast Specification (70L-7A) OPT : Shaft Type Fork&carriage

Model	Mast Type	Maximum Fork height		Overall Height								Free Lift				Tilt Angle		Load capacity w/o side shift At 24 in (600mm)LC		Load capacity w/side shift At 24 in (600mm) LC		TRUCK WEIGHT UNLOADED	
				Lowered		Extended				Without Load Backrest		With Std Load Backrest											
				in	mm	in	mm	W/o Load Backrest		W/Std Load Backrest		in	mm	in	mm	Fwd	Bwd	lb	kg	lb	kg	lb	kg
						in	mm	in	mm	deg	deg												
70L-7A	2-STAGE LIMITED FREE LIFT	V270	107	2730	93	2365	-	-	156.5	3975	-	-	5.5	140	15	10	15436	7000	-	-	20853	9457	
		V300	119	3030	99	2515	-	-	168.3	4275	-	-	5.5	140	15	10	15436	7000	-	-	20961	9506	
		V330	131	3330	105	2665	-	-	180.1	4575	-	-	5.5	140	15	10	15436	7000	-	-	21063	9552	
		V350	139	3530	109	2765	-	-	188.0	4775	-	-	5.5	140	15	10	15436	7000	-	-	21133	9584	
		V370	147	3730	113	2865	-	-	195.9	4975	-	-	5.5	140	15	10	15436	7000	-	-	21204	9616	
		V400	159	4030	119	3015	-	-	207.7	5275	-	-	5.5	140	15	10	15436	7000	-	-	21327	9672	
		V450	178	4530	131	3315	-	-	227.4	5775	-	-	5.5	140	15	10	15436	7000	-	-	21830	9900	
		V500	198	5030	140	3565	-	-	247.0	6275	-	-	5.5	140	15	10	15436	7000	-	-	22004	9979	
	3-STAGE FULL FREE LIFT	V550	218	5530	150	3815	-	-	266.7	6775	-	-	5.5	140	15	10	15436	7000	-	-	22181	10059	
		V600	237	6030	160	4065	-	-	286.4	7275	-	-	5.5	140	15	10	14994	6800	-	-	22353	10137	
		V700	277	7030	180	4565	-	-	325.8	8275	-	-	5.5	140	15	6	14774	6700	-	-	22611	10254	
		TF450	180	4560	101	2565	-	-	228.5	5805	-	-	52	1320	15	10	15436	7000	-	-	22260	10095	
		TF500	199	5060	109	2765	-	-	248.2	6305	-	-	60	1520	15	10	15215	6900	-	-	22463	10187	
		TF560	220	5600	117	2965	-	-	269.5	6845	-	-	68	1720	15	10	14774	6700	-	-	22708	10298	
		TF600	239	6060	125	3165	-	-	287.6	7305	-	-	76	1920	15	10	14333	6500	-	-	22902	10386	
		TS450	180	4560	101	2565	-	-	228.5	5805	-	-	52	1320	15	10	15436	7000	-	-	22260	10095	
TS500	199	5060	109	2765	-	-	248.2	6305	-	-	60	1520	15	10	15215	6900	-	-	22463	10187			
TS560	220	5600	117	2965	-	-	269.5	6845	-	-	68	1720	15	10	14774	6700	-	-	22708	10298			
TS600	239	6060	125	3165	-	-	287.6	7305	-	-	76	1920	15	10	14333	6500	-	-	22902	10386			

### Load Capacity

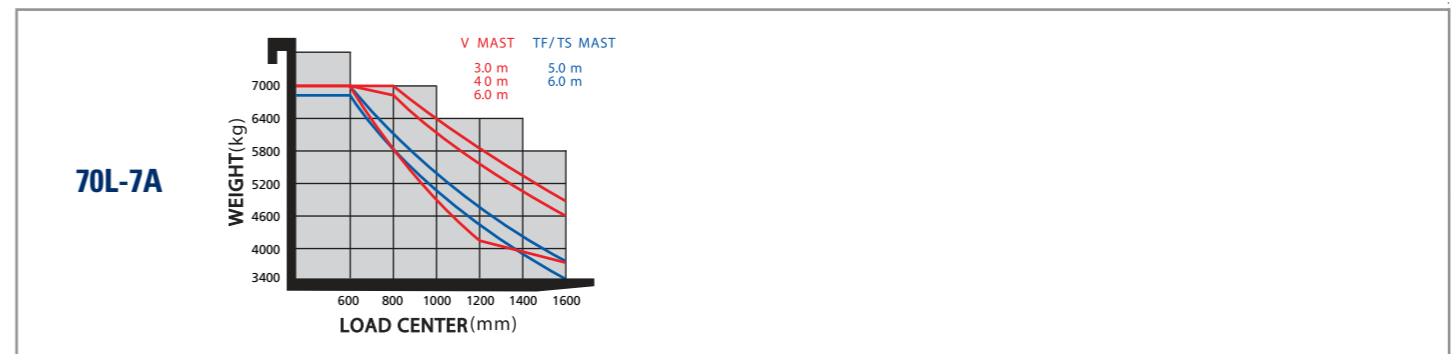

### Various Attachments

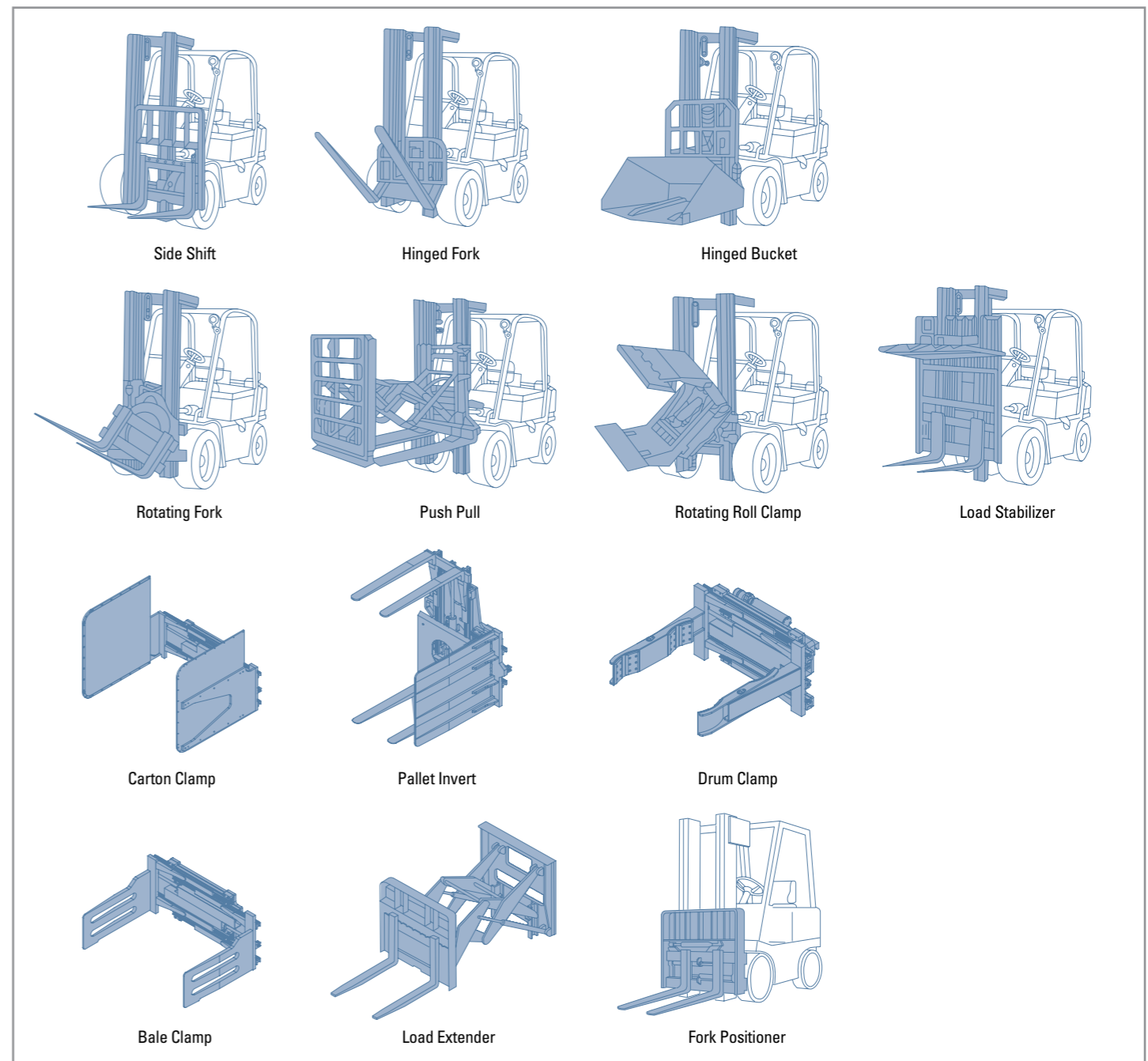

## Optional Items

- **FORK (mm)** : 1200(STD), 1350, 1500, 1800, 2000, 2300, 2400
- **TIRE** : SOLID (SUPERELASTIC), NON-MARKING
- **SEAT** : SEAT BELT, ARM REST, HIP REST
- **INTERNAL PIPING**
- **CABIN & HEATER** : CABIN, HEATER
- **MUFFLER** : HORIZONTAL
- **LPG TANK CLAMP** : DUAL
- **MASTER SWITCH**
- **ELE.BEACON**
- **HAZARD SWITCH**
- **MCV** : 3-SPOOL / 4-SPOOL / 5-SPOOL
- **SIDE SHIFT**
- **INTEGRAL FORK POSITIONER CARRIAGE**
- **INTEGRAL SIDE SHIFT CARRIAGE**
- **INTEGRAL S/S WITH F/P CARRIAGE**

※ The options in this brochure are subject to change to improve the performance of the forklift.

## Dimension

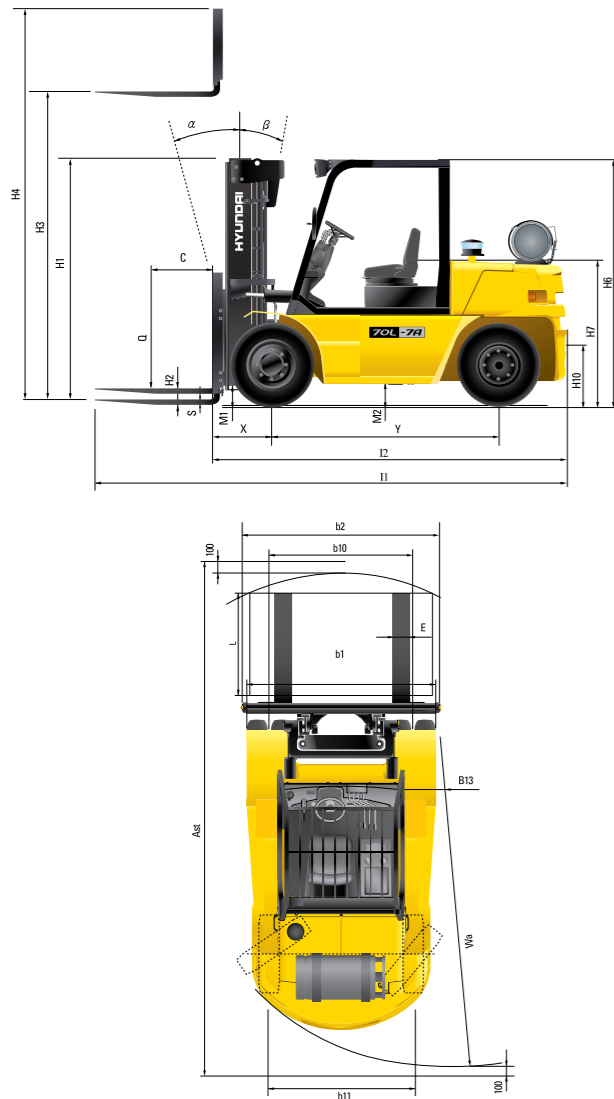

## Specification

Identification		
1.1	Manufacturer	Hyundai
1.2	Manufacturer's type designation	70L-7A
1.3	Drive: electric (battery or mains), diesel, petrol, fuel gas, manual	LP
1.4	Type of operation: hand, pedestrian, standing, seated, order-picker	seated
1.5	Load capacity / rated load	Q (kg) 7,000
1.6	Load center distance	c (mm) 600
1.8	Load distance, center of drive axle to fork	x (mm) 615
1.9	Wheelbase	y (mm) 2,300
Weights		
2.1	Service weight	kg 9,430
2.2	Axle loading, loaded front/rear	kg 14,564 / 1,866
2.3	Axle loading, unloaded front/rear	kg 3,867 / 5,564
Wheels, Chassis		
3.1	Tires: solid rubber, superplastic, pneumatic, polyurethane	Pneumatic
3.2	Tires size, front	8.25-15-14PR
3.3	Tires size, rear	8.25-15-14PR
3.5	Wheels, number front x rear (x=driven wheels)	4x2
3.6	Track width, front	b10 (mm) 1,578
3.7	Track width, rear	b11 (mm) 1,604
Basic Dimensions		
4.1	Mast / fork carriage tilt forward / backward ( $\alpha/\beta$ )	degrees 15 / 10
4.2	Lowered mast height	h1 (mm) 2,515
4.3	Free lift	h2 (mm) 140
4.4	Lift height	h3 (mm) 3,030
4.5	Extended mast height	h4 (mm) 4,320
4.7	Overhead guard (cab) height	h5 (mm) 2,500
4.8	Seat height / standing height	h7 (mm) 1,395
4.12	Coupling height	h10 (mm) 425
4.19	Overall length	l1 (mm) 4,820
4.20	Length to face of forks	l2 (mm) 3,620
4.21	Overall width	b1 (mm) 2,087
4.22	Fork dimensions	s / e / l (mm) 65 x 150 x 1,200
4.23	Fork carriage ISO 2328, class / type A,B	Class IV
4.24	Fork-carriage width	b12 (mm) 2,068
4.31	Ground clearance, loaded, under mast	m1 (mm) 195
4.32	Ground clearance, centre of wheelbase	m2 (mm) 220
4.33	Aisle width for pallets 1000x1200 crossways	Ast (mm) 5,185
4.34	Aisle width for pallets 800x1200 lengthways	Ast (mm) 5,385
4.35	Turning radius	Wa (mm) 3,370
4.36	Smallest pivot point distance	b13 (mm) 1,224
Performance Data		
5.1	Travel speed, Unloaded	km/h 22.4
5.2	Lift speed, Loaded/Unloaded	mm/s 420 / 430
5.3	Lowering speed, Loaded/Unloaded	mm/s 500 / 450
5.5	Drawbar pull, Loaded	kg 6,861
5.7	Gradient performance, Loaded	% 40.6
5.10	Service brake	Foot : Hydraulic
Engine		
6.1	Engine manufacturer / type	PSI 4.3L V6
6.2	Engine power acc. to ISO 1585	kW 78
6.3	Rated speed	1/min 2,300
6.4	No. of cylinder / cubic capacity	/cm <sup>3</sup> 6 / 4,294
Other Details		
8.2	Type of drive control	Power Shift
8.3	Operating pressure	bar 185
8.4	Oil volume(system)	ℓ 94
8.5	Noise	db(A) 82

※ The specifications in this brochure are subject to change for option.

## MEMO